

CORNERS GRINDING MACHINES  
HORIZONTAL DRILLING MACHINES

# COM PLEMEN TARY PROCESSING SOLU TIONS

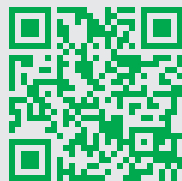

**ADELIO LATTUADA®**  
EVOLUTION OF GLASS WORKING  
*Since 1970*



[www.adeliolattuada.com](http://www.adeliolattuada.com)

## COMPLEMENTARY PROCESSING MACHINES



### **DELTA SERIES**

Corners grinding machines

14

---



### **TP SERIES**

Horizontal drilling machines

18

---

# WHY OPT FOR LATTUADA

GAME CHANGING VALUES

## more passion

**Passion, technology, service: 40 years of made in Italy.  
Flexible solutions and high-quality.**

Each customer can always count on our best resources, and each project stimulates our R&D to find fully customised solutions designed on individual production needs.

## more ambition

**90% of production exported  
more than 3000 machines sold since 1978**

We always strive to be a step ahead so as to offer our customers solutions capable of tangibly boosting the efficiency and quality of the production process.

## more automation

We are in a position to offer flexible and customised **new integration solutions**, with the following advantages: increasing the level of automation, flexibility, productivity, optimising production and cutting costs.

## more service

Proper maintenance helps keeping machines in optimal and efficient operating conditions all the time, their performance at maximum level ... and customers satisfied.

Manufacturing **machines requiring the least and easiest maintenance** has always been one of our strong points.

## more quality

**We have set up an internal and external supply chain that ensures the highest standards of reliability.**

We directly take care of the design, selection of suppliers and components; we monitor each processing step, regarding both electrical and mechanical; we study the programming and automation of the software.

## more internationality

**2017 marked the incorporation of LATTUADA NORTH AMERICA, INC.,** in Northwood (OH). The aim of this company is reinforcing our presence in the United States and providing any kind of pre and post sales service.

## more organisation

**We address each project methodically,** following a structured workflow which ensures maximum quality and reliability. A streamlined and coordinated development where all steps are monitored to ensure the required results are achieved and on time.

## more technology

**Industry 4.0 is the keyword**

Thanks to a platform accessible by any device, Lattuada machines are getting smarter and more communicative by the day. This allows the manufacturer and the user to be connected all the time.

## more customer satisfaction

**At Lattuada, customer satisfaction is our topmost objective.**

The key factor lies in interpreting needs, striving towards winning solutions. Flexibility, production capacity and skills combine with an ever-guaranteed support aimed at providing supreme quality products and instant response times.

MADE IN LATTUADA  
INTEGRATED SOLUTIONS,  
TO MEET ALL YOUR NEEDS

# THE WORLD OF LATTUADA

## INDUSTRY 4.0 SOLUTIONS

7

Are you ready for the fourth industrial revolution? We can support you in the streamlining of production processes by offering high-tech solutions to digitise, connect, monitor, manage and optimise data in real time.



6

## STONE WORKING SOLUTIONS

We know the specificities of stone processing. This is why we can design with you the perfect machine to process marble, stone and synthetic and composite materials.

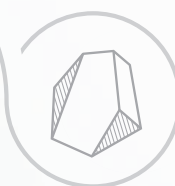

5

## COMPLEMENTARY GLASS PROCESSING SOLUTIONS

Do you need to drill or process corners? We can provide a complete range of horizontal drilling machines and automatic radius and straight corners grinding machines.

- > **corners grinding machines**
- > **horizontal drilling machines**



4

## SPECIAL MACHINES SOLUTIONS

Do you have any special needs? Out-of-standard processes? Do you treat composite materials? That's not a problem. We can find the most suitable solution for you and customise our machines to ensure you get the flexibility you need.

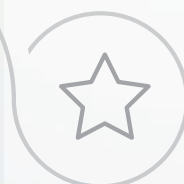

inte



## GRINDING SOLUTIONS

Our strength, always. A variety of solutions taking the shape of a wide range of machines: more than 40 models that can be specifically configured to ensure maximum productivity.



- > edging machines
- > double-edgers
- > bevelling machines



## WASHING SOLUTIONS

For more than 15 years we have been studying and providing solutions for glass washing. We offer a full range of high-tech, vertical washing machines that are easy to use and maintain.



## AUTOMATION AND ROBOTICS SOLUTIONS (CYBERAL)

We are constantly formulating solutions to operate at the highest levels of automation, making the most of integration with robotics to increase productivity and reduce costs.

1

2

3

# cyberAL

## A CHOICE THAT GIVES YOU MORE

### CYBERAL, AUTOMATION AND INTERCONNECTION FOR A TRULY INTEGRATED INDUSTRIAL PRODUCTION

Robots, automation, integration, Industry 4.0: glass processing steps into a new era. Those who opt for advanced solutions and technology can count on an effective competitive edge. Right from today, Adelio Lattuada will be by your side to help you achieve this new production and flexibility goal through CYBERAL.

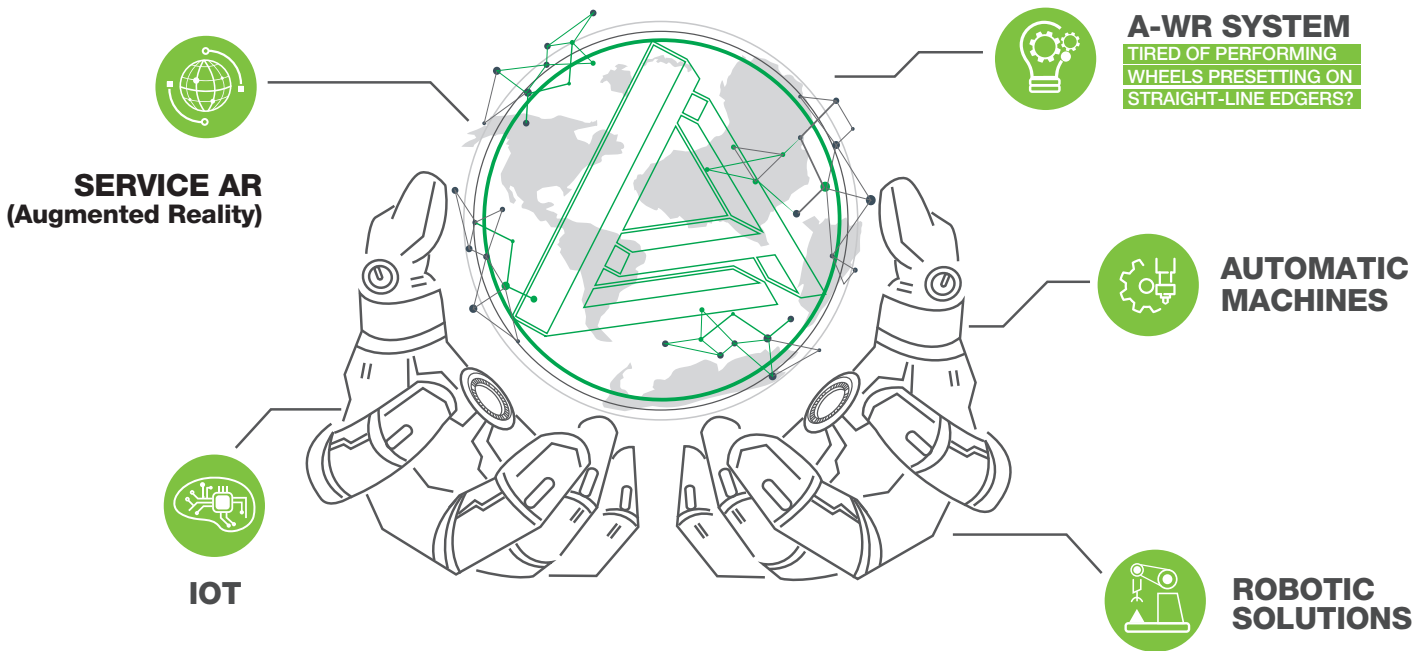

### A PERFECT SYNERGY WITH TECHNOLOGY

# ROBOTS

NEW INTEGRATED, FLEXIBLE AND CUSTOMISED SOLUTIONS WITH THE FOLLOWING ADVANTAGES

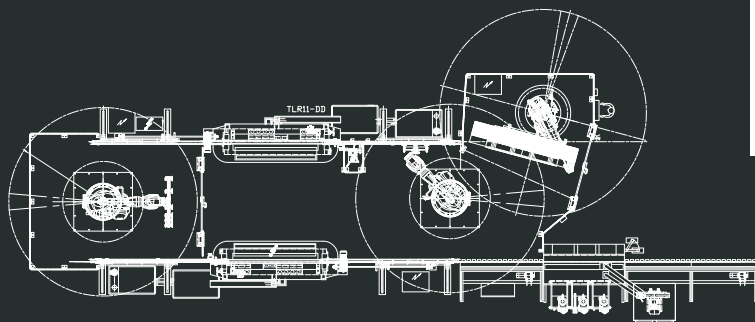

In partnership with:



### DIFFERENT CONFIGURATIONS AVAILABLE FOR THE IMPLEMENTATION IN SEVERAL APPLICATIONS:

- (A) 2 EDGERS AND 1 ROBOT**  
The most sold
- (B) 2 EDGERS AND 2/3 ROBOTS**  
For fully automated cells
- (C) 1 EDGER AND 1 ROBOT**  
Fully automated cell in a reduced space
- (D) 4 EDGERS AND 3 ROBOTS**  
Special solutions
- (E) INTEGRATION**  
With washers, CNCs, double-edgers, cutting, tempering or IG lines, etc.



SOLUTIONS FOR AUTOMATING ACTIVITIES  
AND INCREASING PRODUCTION FLEXIBILITY

# AUTOMATIC MACHINES

## A-WR SYSTEM

For a completely automatic wheels setting management.



## i-AL

Comprehensive pack of mechanical, electronic and software systems especially designed to deliver the maximum possible automation in glass processing and a full integration with your entire production system.



## SOLUTIONS FOR TRANSFORMING PRODUCTION AND BECOMING A SMART FACTORY

# INDUSTRY 4.0

An approach that deeply changes the production process by implementing enabling technologies: a leap you can already take into the future through Adelio Lattuada products.

As a matter of fact, thanks to the **PLM IOT i-Like Machines** software, besides connecting machines to each other so as to monitor them constantly, we also provide clear data through an interface that is intuitive and easy to use.

**THIS WILL ALLOW YOU TO:**

- monitor production cycle in real time
- receive alerts in case of malfunctions
- optimise plant availability and production
- plan maintenance works
- reduce failures and downtime
- view machine use data and report records

**CORNERS GRINDING MACHINES  
AND DRILLING MACHINES**

# **SOLUTIONS FOR COMPLEMENTARY PROCESSING**



**performing**  
high speed

**Corners grinding machines:**  
cycle time less than 30"  
for thicknesses up to 20 mm.



**productive**  
smart technology

**Drilling machines:** laser centring  
system and supports for drilling  
in series.



**reliable**  
little maintenance required

Machines with extremely long  
useful life and extremely  
easy to maintain.



**Specific machines for automatically processing radius and straight corners**, thus recommended for example for glassmakers who manufacture large volumes of furnishing shelves or doors.

**Complete line of automatic, semi-automatic and manual horizontal drilling machines** with one or two opposing heads.



## flexible

**customised configurations**

**Corners grinding machines:** you can work on different types of corners and profiles depending on the assembled type of tools.



## smart

**simplicity of use**

**Drilling machines:** automatic adjustment of the diamond tool speed by setting the drilling diameter.



## excellent

**top performance**

Thanks to optionals such as the use of liquid cerium oxide, our corners grinding machines can offer high final processing quality.



# CORNERS GRINDING MACHINES

## TECHNICAL DETAILS

- 1 Movement of the **pneumatic wheel-holder units**.
- 2 Spindle **adjustment handwheels**.
- 3 Option to work in **automatic cycle**.
- 4 **Manual lubrication** of all rotary parts.
- 5 Integrated support for processing **medium size sheets**.
- 6 Simple and quick **positioning of the templates**.



# HORIZONTAL DRILLING MACHINES

## TECHNICAL DETAILS

- 1 **Automatic ejection** of the glass cores (not available for the TP 1000 version).
- 2 **Laser centring system**.
- 3 **Pneumatic glass support table**.
- 4 **Automatic adjustment of the diamond tool speed** by setting the drilling diameter (not available for the TP 1000 version).

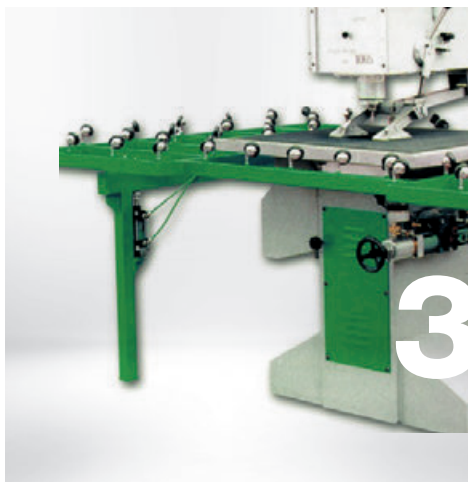
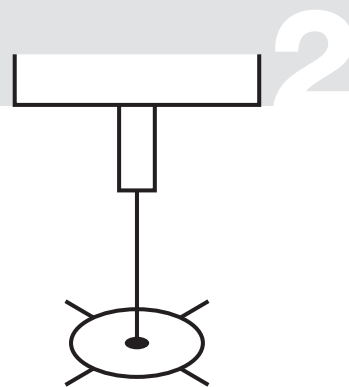

# DELTA SERIES

## SPECIFIC MACHINES FOR AUTOMATIC PROCESSING OF CORNERS

The DELTA series comprises specific machines for automatically processing corners, thus recommended for example for glassmakers who manufacture large volumes of furnishing shelves or doors.

They can process radius or straight corners on thicknesses up to 20 mm in less than 30 seconds, even with liquid cerium oxide polishing.



4 - 20 mm  
5/32 - 3/4 "



10 - 150 mm  
25/64 - 6 "



10 - 200 mm  
25/64 - 7.9 "



pneumatic

## CORNERS GRINDING MACHINES DELTA SERIES

# ALL YOU NEED TO KNOW

How flexible and modular are they?

- Simple and quick positioning of the templates
- Independent adjustment of top and bottom aris
- Integrated support for processing medium size sheets
- Table with wheels for processing large glass sheets

Which are the production control tools?

- Spindle adjustment handwheels
- Processing speed oleodynamic adjuster

Which components of the machine allow achieving high performance?

- Option to work in automatic cycle: cycle time less than 30" for thicknesses up to 20 mm
- Movement of the pneumatic wheel-holder units
- Device for processing small pieces

How can I achieve higher quality?

- Liquid cerium oxide for greater processing quality

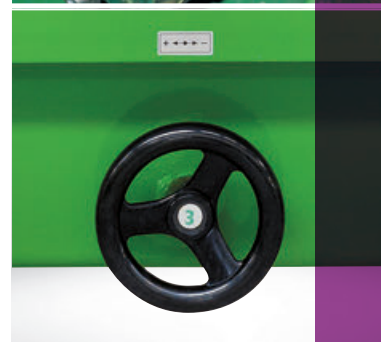
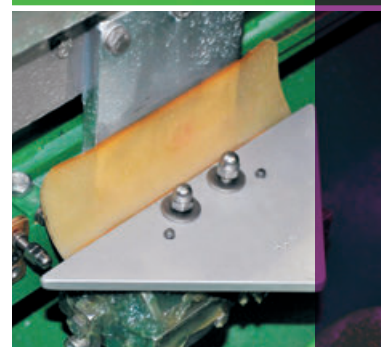
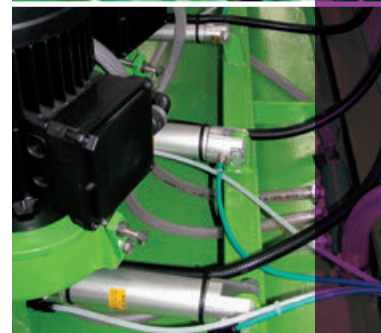

# DELTA SERIES

THE FLEET



Corners grinding machines



# DELTA SERIES

Automatic machines for **processing radius and straight corners**

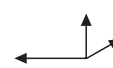

<b>DELTA M3</b>	<b>eu</b>	200x300 mm opt. 100x200 mm	1.000x1.000 mm (square glasses) 1.300x700 mm (rectangular glasses)	10 - 150 mm	10 - 200 mm	4 - 20 mm	8,5	2.200x1.150 xH1.750 mm	900 Kg	
	<b>us</b>	7.9x11.8 " opt. 3.9x7.9 "	39.4x39.4 " (square glasses) 51.2x27.5 " (rectangular glasses)	25/64 - 6 "	25/64 - 7.9 "	25/64 - 7.9 "		86.6x45.3 xH68.9 "	1,984 lbs	
								3	2	1

<b>DELTA M4</b>	<b>eu</b>	200x300 mm opt. 100x200 mm	1.000x1.000 mm (square glasses) 1.300x700 mm (rectangular glasses)	10 - 150 mm	10 - 200 mm	4 - 20 mm	11	2.680x1.300 xH1.750 mm	1000 Kg		
	<b>us</b>	7.9x11.8 " opt. 3.9x7.9 "	39.4x39.4 " (square glasses) 51.2x27.5 " (rectangular glasses)	25/64 - 6 "	25/64 - 7.9 "	25/64 - 7.9 "		105.5x51.2 xH68.9 "	2,205 lbs		
								4	3	2	1

<b>DELTA M4 C</b>	<b>eu</b>	200x300 mm opt. 100x200 mm	1.000x1.000 mm (square glasses) 1.300x700 mm (vetri rettangolari)	10 - 150 mm	10 - 200 mm	4 - 20 mm	11	2.680x1.300 xH1.750 mm	1000 Kg		
	<b>us</b>	7.9x11.8 " opt. 3.9x7.9 "	39.4x39.4 " (square glasses) 51.2x27.5 " (rectangular glasses)	25/64 - 6 "	25/64 - 7.9 "	25/64 - 7.9 "		105.5x51.2 xH68.9 "	2,205 lbs		
								4	3	2	1

<b>DELTA M5</b>	<b>eu</b>	200x300 mm opt. 100x200 mm	1.000x1.000 mm (square glasses) 1.300x700 mm (rectangular glasses)	10 - 150 mm	10 - 200 mm	4 - 20 mm	13	3.000x1.300 xH1.750 mm	1200 Kg			
	<b>us</b>	7.9x11.8 " opt. 3.9x7.9 "	39.4x39.4 " (square glasses) 51.2x27.5 " (rectangular glasses)	25/64 - 6 "	25/64 - 7.9 "	25/64 - 7.9 "		118.1x51.2 xH68.9 "	2,640 lbs			
								5	4	3	2	1

## LEGEND



# TTP SERIES

## SEMI-AUTOMATIC AND AUTOMATIC MANUAL HORIZONTAL DRILLING MACHINES

Complete line of automatic, semi-automatic and manual horizontal drilling machines with one or two opposing heads (bottom automatic and top manual). Common features are the automatic locking of the glass during the drilling cycle and the option to adjust the drilling depth on the bottom head. Just like for all of our models, they come in various options, thus allowing utmost customisation and adaptation of the product to the various needs.



Ø 4 - 200 / 250 mm  
Ø 5/32 - 7.9 / 9.8 "



Ø 4 - 130 mm  
Ø 5/32 - 5.1 "



50 mm  
2 "



1.000 / 1.065 / 1.200 / 1.665 mm  
39.3 / 41.9 / 47.2 / 65.5 "

# HORIZONTAL DRILLING MACHINES TP SERIES

## ALL YOU NEED TO KNOW

How flexible and modular are they?

- Pneumatic glass support table
- Option to adjust the drilling depth on the bottom head

Which are the production control tools?

- Automatic locking of the glass during the drilling cycle

Which components of the machine allow achieving high performance?

- Automatic ejection of the glass cores
- Laser centring system
- Supports for drilling in series

How can I achieve higher quality?

- Automatic adjustment of the diamond tool speed by setting the drilling diameter (not available for the TP 1000 version)

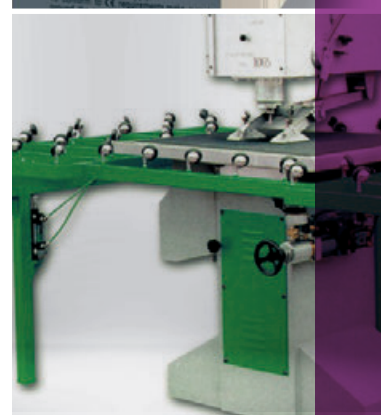

# TP

# SE RIES

THE FLEET

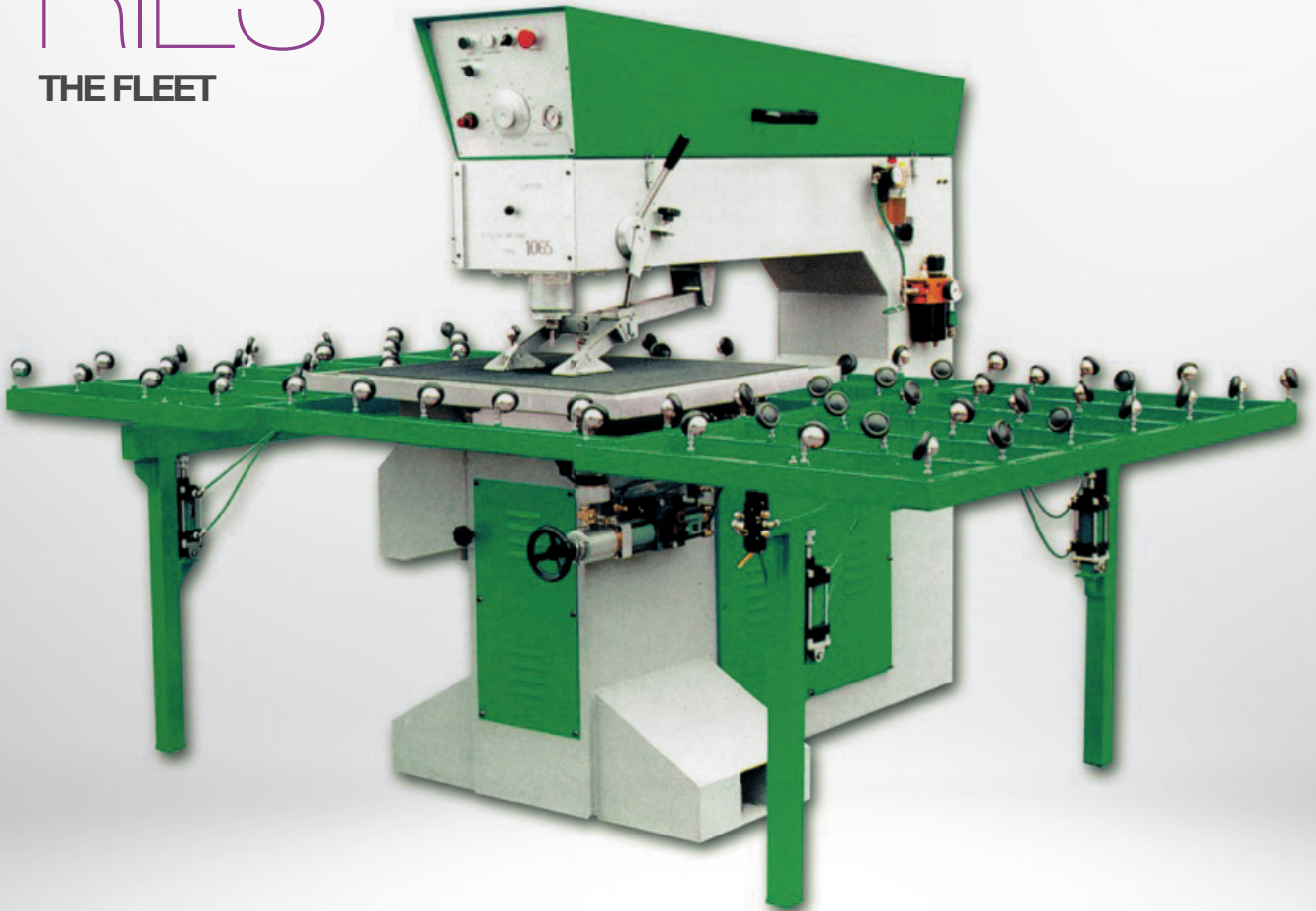

Manual and semi-automatic  
horizontal drilling machines

## SERIE TP

### Manual horizontal drilling machines



TP 1000.1H	eu	Ø 4 - 200 mm	-	1000 mm	50 mm	1,5	1.700x1.300 xH1.800 mm	270 Kg
	us	Ø 5/32 - 7.9 "	-	39.4 "	2 "		66.9x51.1 xH70.8 "	595 lbs

TP 1000.2H	eu	Ø 4 - 200 mm	Ø 4 - 130 mm	1000 mm	50 mm	2,5	1.700x1.300 xH1.800 mm	320 Kg
	us	Ø 5/32 - 7.9 "	Ø 5/32 - 5.1 "	39.4 "	2 "		66.9x51.1 xH70.8 "	705 lbs

Available also the automatic version

## SERIE TP

### Semi-automatic horizontal drilling machines



TP 1065	eu	Ø 4 - 250 mm	Ø 4 - 130 mm	1.065 mm	50 mm	3	1.700x900 xH1.760 mm	550 Kg
	us	Ø 5/32 - 9.8 "	Ø 5/32 - 5.1 "	41.9 "	2 "		66.9x35.4 xH69.2 "	1,212 lbs

Available also the automatic version

TP 1200	eu	Ø 4 - 250 mm	Ø 4 - 130 mm	1.200 mm	50 mm	3	1.900x900 xH1.760 mm	650 Kg
	us	Ø 5/32 - 9.8 "	Ø 5/32 - 5.1 "	47.2 "	2 "		74.8x35.4 xH69.2 "	1,433 lbs

Available also the automatic version

TP 1665	eu	Ø 4 - 250 mm	Ø 4 - 130 mm	1.665 mm	50 mm	3	2.700x900 xH1.760 mm	750 Kg
	us	Ø 5/32 - 9.8 "	Ø 5/32 - 5.1 "	65.5 "	2 "		106.2x35.4 xH69.2 "	1,653 lbs

Available also the automatic version

#### LEGEND



drilling diameter  
(with 1 head)



drilling diameter  
(with 2 heads)



useful depth



max glass  
thickness



installed  
power



dimensions



weight

# AS BIG AS THE WORLD

Our solutions are working all over the world.  
Since 2017 we operate in the USA through LATTUADA  
NORTH AMERICA based in Northwood (Ohio).  
A precise corporate choice to stay close to our customers  
by offering top quality services and products specifically  
designed for a demanding and competitive market that  
requires compliance to specific standards.

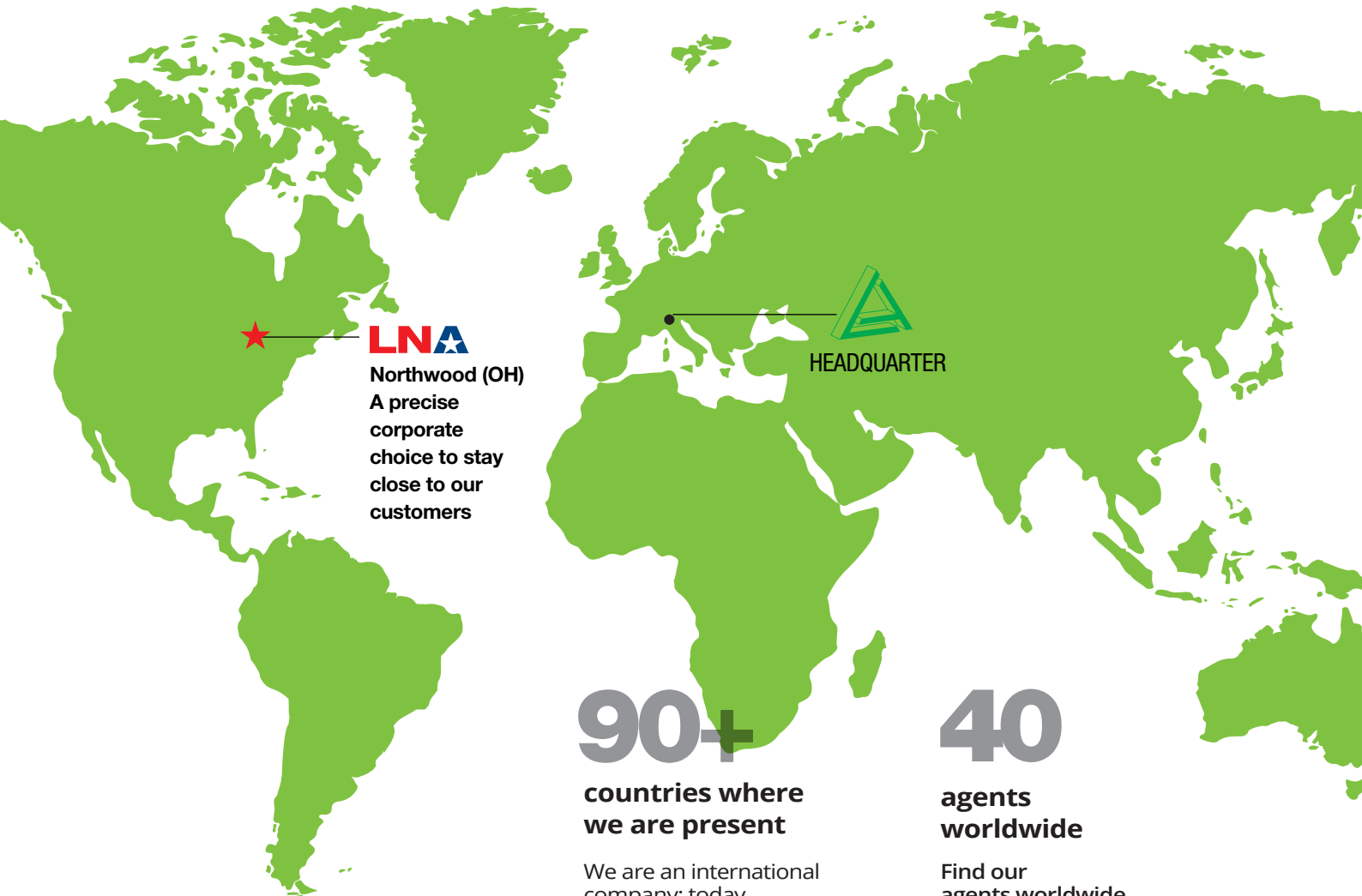

**LNA**  
Northwood (OH)  
A precise  
corporate  
choice to stay  
close to our  
customers

  
HEADQUARTER

**90+**  
countries where  
we are present

We are an international  
company; today  
our machines are working  
in 90 countries.

**40**  
agents  
worldwide

Find our  
agents worldwide.



LNA provides all pre- and after-sale services directly from the united states, including a qualified and highly professional technical support service with longstanding experience in the glass-working machine industry.



This new company allows us to offer endless benefits to all our us customers:

- no more problems related to transportation issues;
- machinery are invoiced directly from the united states, eliminating the currency problem;
- specific services for the us market;
- technical support always available with no more time zone issues;
- spare parts are supplied directly from Lattuada North America.

Adelio Lattuada Srl assumes no responsibility for any mistakes in the contents.  
All data are subject to change without notice.  
Images can be only representative of the products' typology.



**ADELIO LATTUADA®**  
EVOLUTION OF GLASS WORKING  
*Since 1978*

ADELIO LATTUADA S.R.L.  
Via Abbondanza, 11/13 - 22070 Carbonate (CO) IT  
Tel. +39 0331.832713 - [info@adeliolattuada.com](mailto:info@adeliolattuada.com)  
[adeliolattuada.com](http://adeliolattuada.com)

LATTUADA NORTH AMERICA, INC.  
6967 Wales Road, Suite F - Northwood 43619 (OH)  
T. 567 249 4486 - [info@lattuada-na.com](mailto:info@lattuada-na.com)  
[lattuada-na.com](http://lattuada-na.com)